HOUE

ECLIPSE TABLE

DESIGN BY
HENRIK PEDERSEN

Vedligehold

Lamellerne på Deres nye bord er i Polywood. Polywood er et plast materiale som ikke kræver anden vedligeholdelse end normal aftørring med en hårdtopredet klud. Kom eventuelt lidt opvaskemiddel i vandet.

Stenen er fra starten behandlet med olie og vil med tiden blive lysere, ønsker De at granitten skal have en mørkere farve igen, kan De påføre stenolie.

Det anbefales, at du bruger bordskånere og undgår glasprodukter direkte på overfladen i skarpt sollys pga. brandglaseffekten.

Bortset fra granitten som skal tages ind om vinteren, kan produktet stå ude hele året. Vi anbefaler dog at produktet tages ind om vinteren i et tørt rum, da dette vil forlænge levetiden.

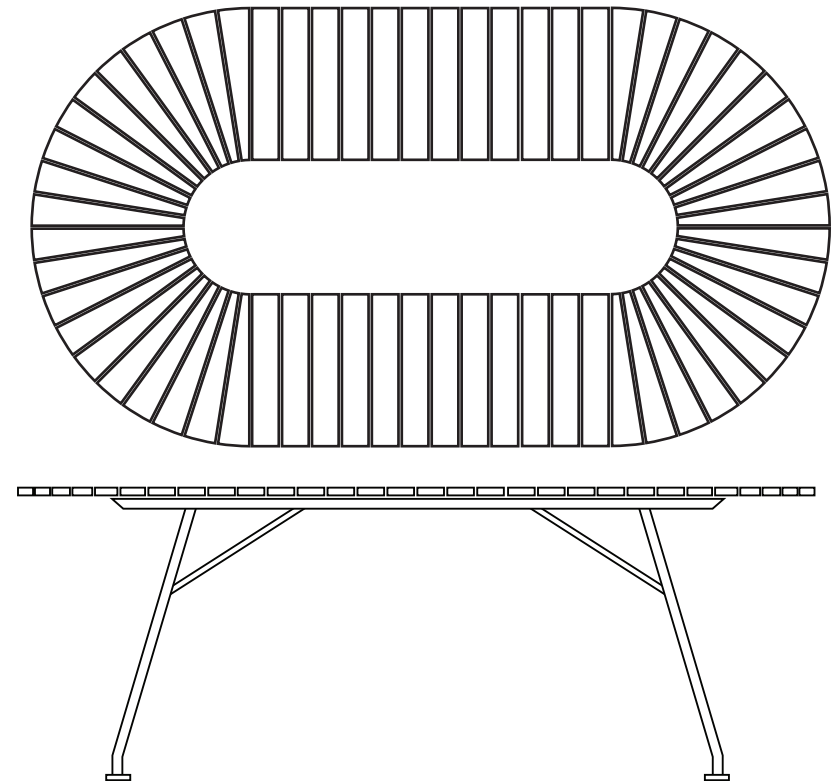

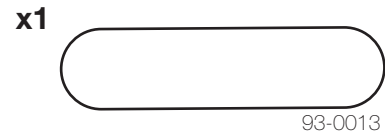
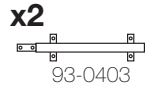
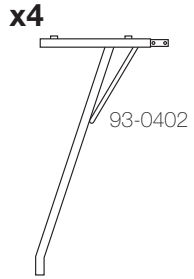
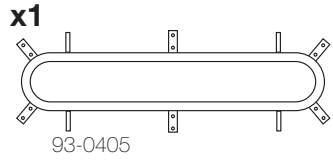
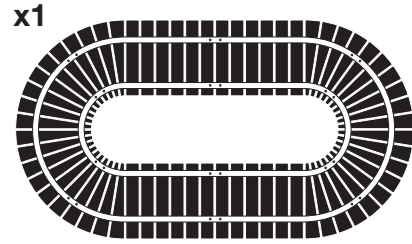
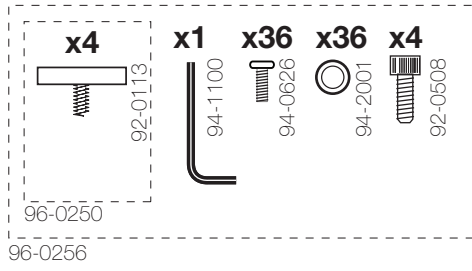

1

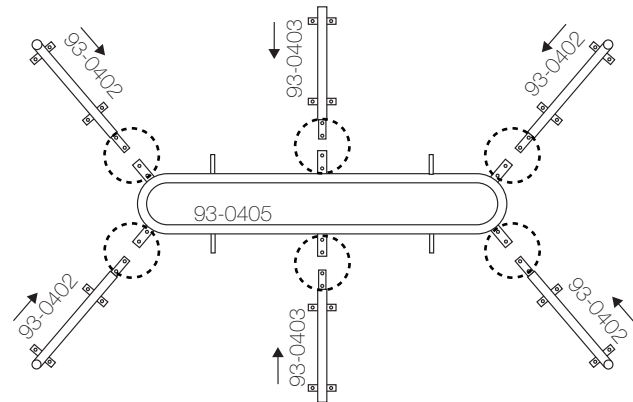

8

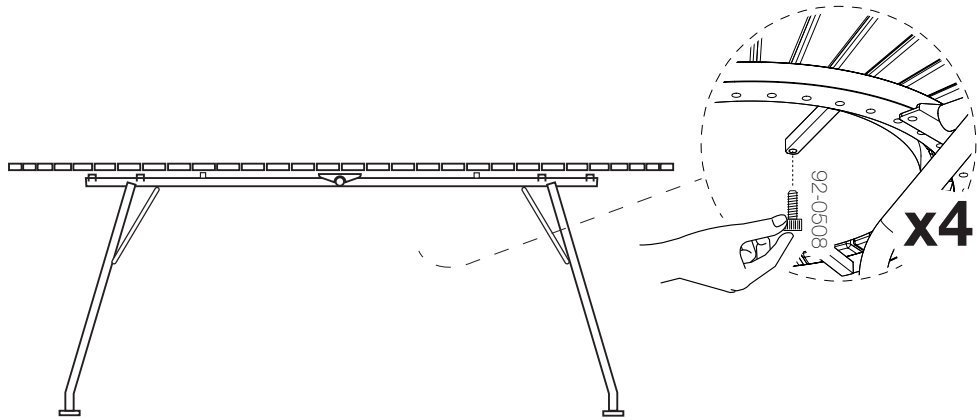

2

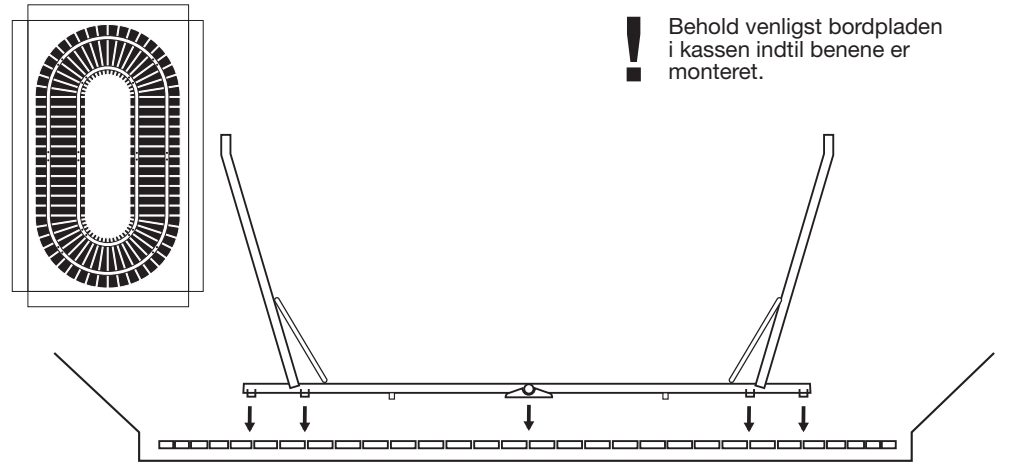

9

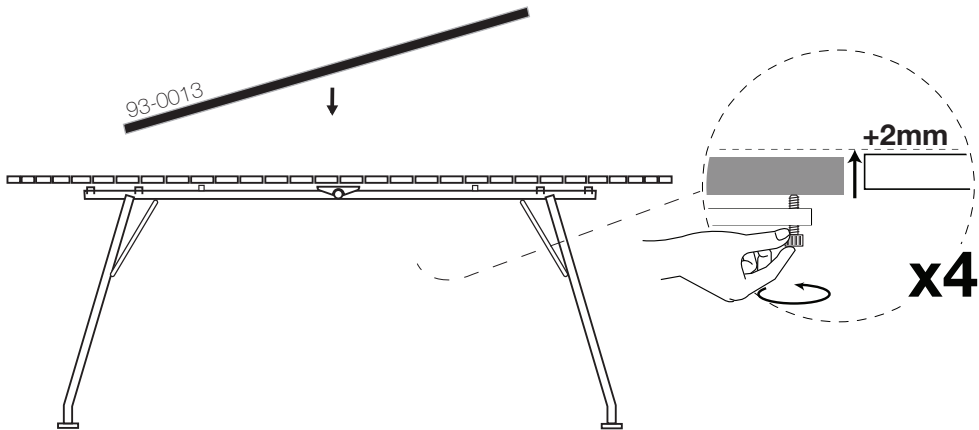

3

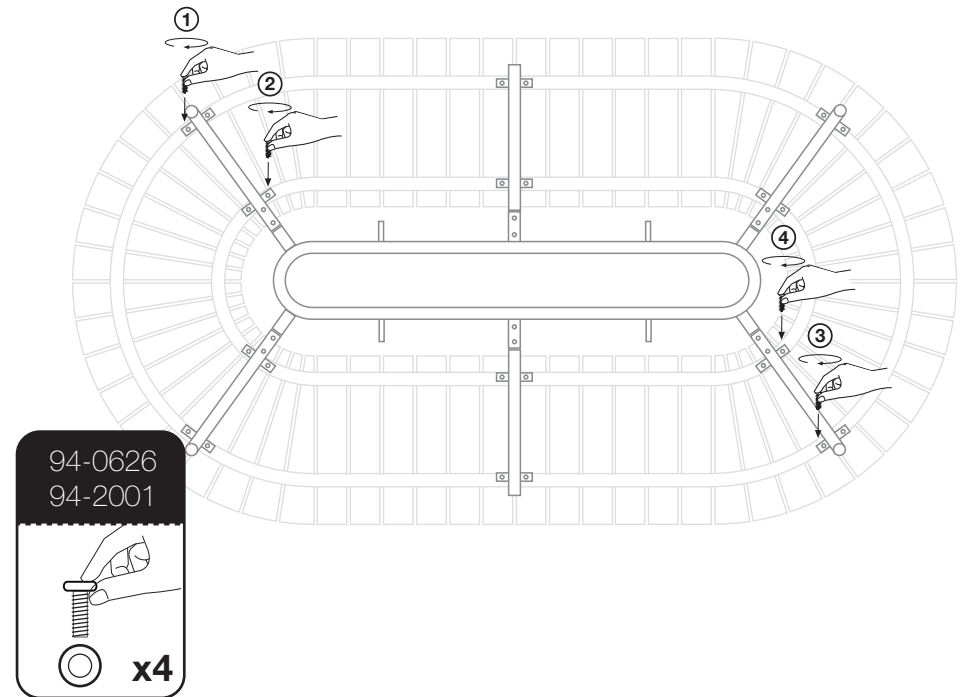

4

94-0626
94-2001

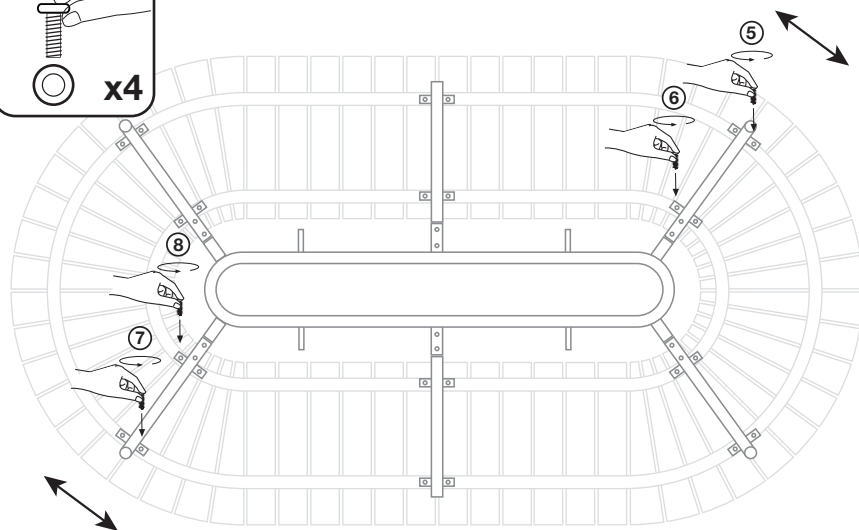

6

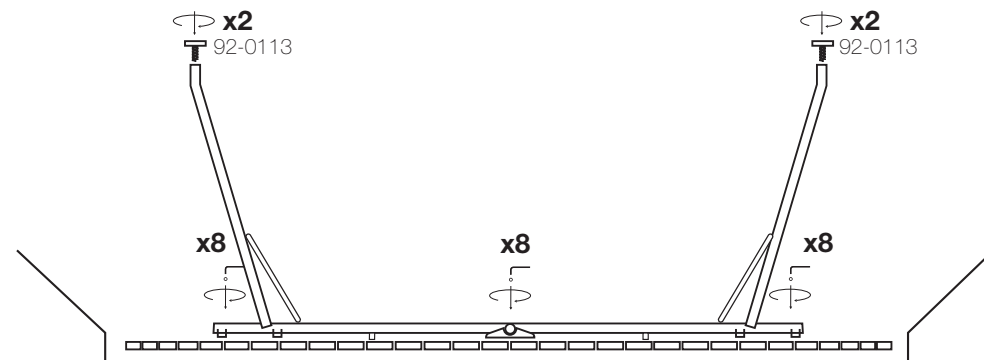

5

94-0626
94-2001

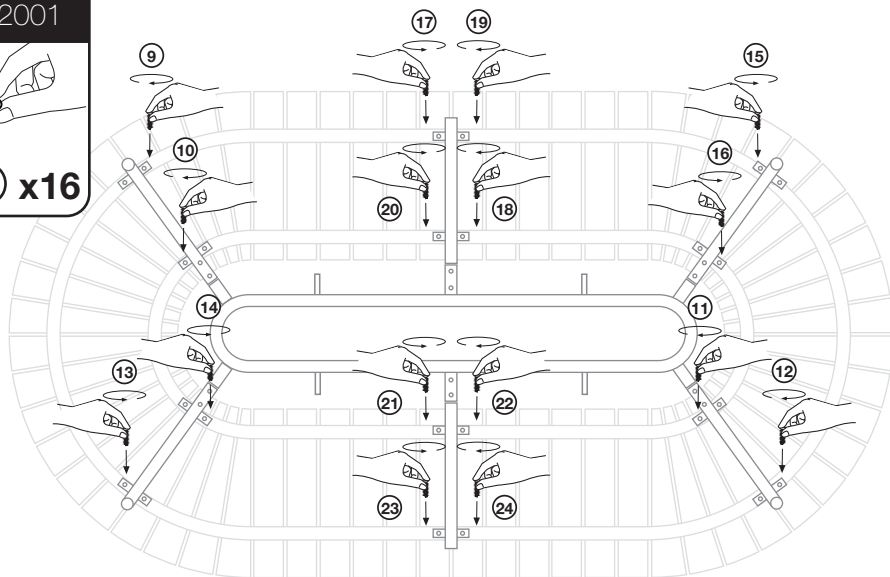

7

