

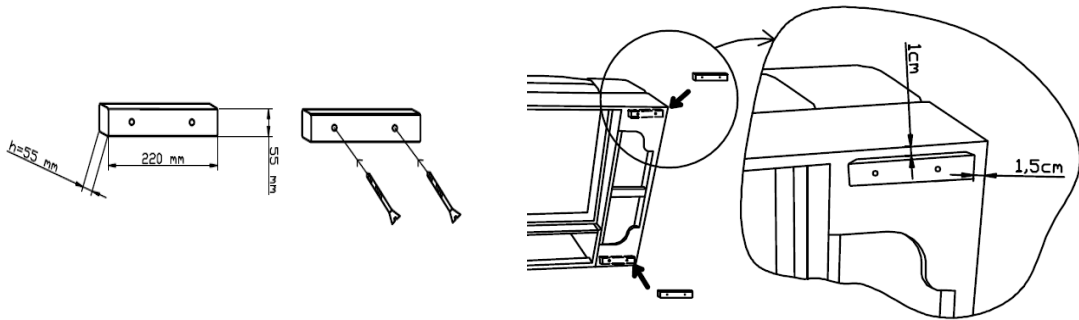

# 1586-Umbria



 -leg/ben/beine



-skruer/screws/schrauben/skruvar

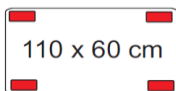
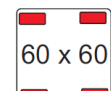
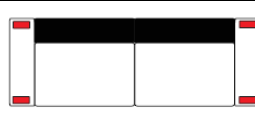
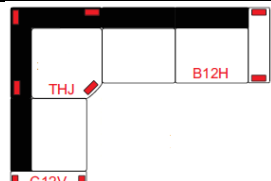
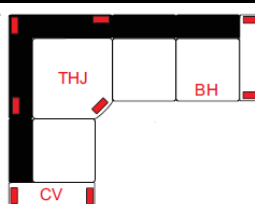
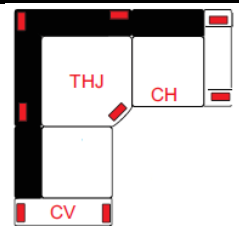
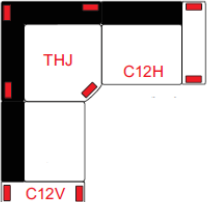
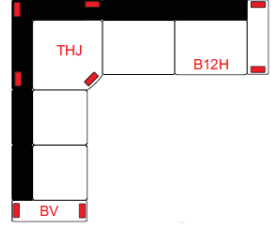
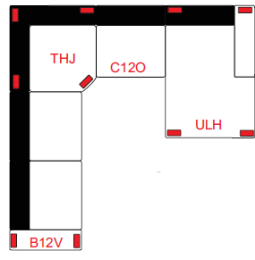
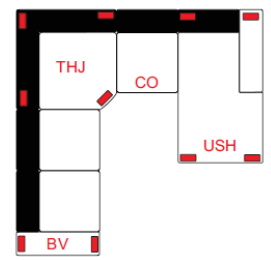

-kroge/hooks/haken/krokar

LL	 <p>110 x 60 cm Opstilling LL</p> <p>Legs-4 Screws-8</p>	LS	 <p>Smaller legs 160mm Opstilling LS</p> <p>Legs-4 Screws-8</p>
A,B12, B,C	 <p>Legs-4 Screws-8</p>	1H	 <p>Legs-8 Hooks-4 Screws-16</p>
2H	 <p>Legs-8 Hooks-4 Screws-16</p>	3	 <p>Legs-8 Hooks-4 Screws-16</p>
4	 <p>Legs-8 Hooks-4 Screws-16</p>	5H	 <p>Legs-8 Hooks-4 Screws-16</p>
6H	 <p>Legs-10 Hooks-6 Screws-20</p>	7H	 <p>Legs-10 Hooks-6 Screws-20</p>

# 1586-Umbria

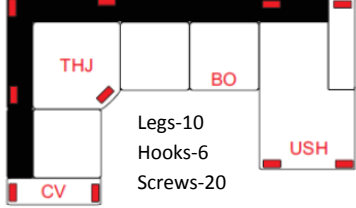
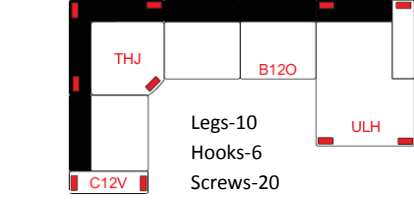
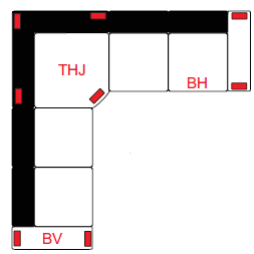
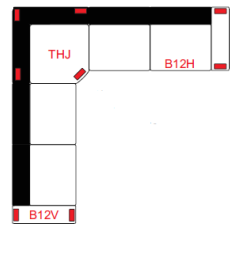
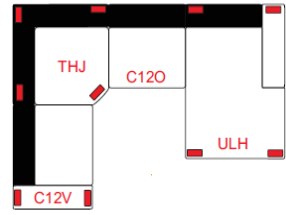
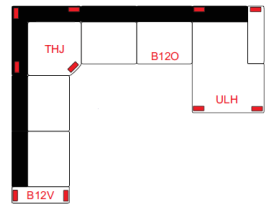
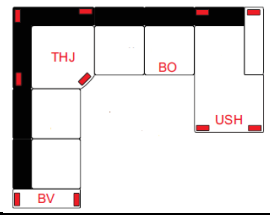
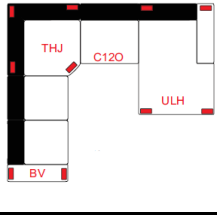
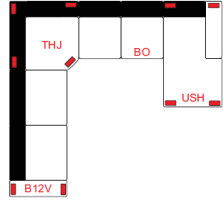
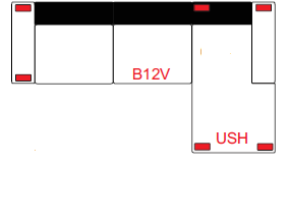
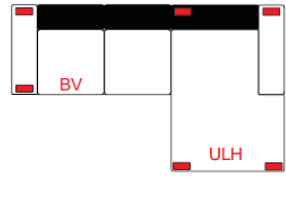
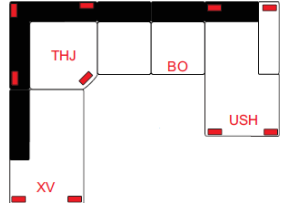
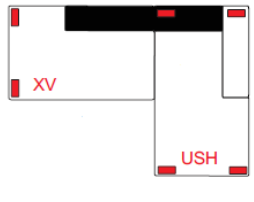
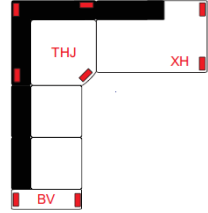
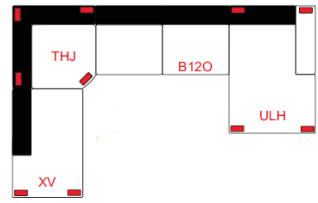
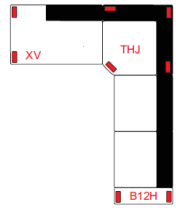
<p>8H</p>	 <p>Legs-10 Hooks-6 Screws-20</p>	<p>9H</p>	 <p>Legs-10 Hooks-6 Screws-20</p>
<p>10</p>	 <p>Legs-8 Hooks-4 Screws-16</p>	<p>11</p>	 <p>Legs-8 Hooks-4 Screws-16</p>
<p>12H</p>	 <p>Legs-10 Hooks-6 Screws-20</p>	<p>13H</p>	 <p>Legs-10 Hooks-6 Screws-20</p>
<p>14H</p>	 <p>Legs-10 Hooks-6 Screws-20</p>	<p>15H</p>	 <p>Legs-10 Hooks-6 Screws-20</p>
<p>16H</p>	 <p>Legs-10 Hooks-6 Screws-20</p>	<p>17H</p>	 <p>Legs-6 Hooks-2 Screws-12</p>
<p>18H</p>	 <p>Legs-6 Hooks-2 Screws-12</p>	<p>19H</p>	 <p>Legs-10 Hooks-6 Screws-20</p>
<p>20H</p>	 <p>Legs-6 Hooks-2 Screws-12</p>	<p>21H</p>	 <p>Legs-8 Hooks-4 Screws-16</p>
<p>34H</p>	 <p>Legs-10 Hooks-6 Screws-20</p>	<p>35H</p>	 <p>Legs-8 Hooks-4 Screws-16</p>