

MODEL "1586/87"

Chaislong

ASSEMBLY INSTRUCTION

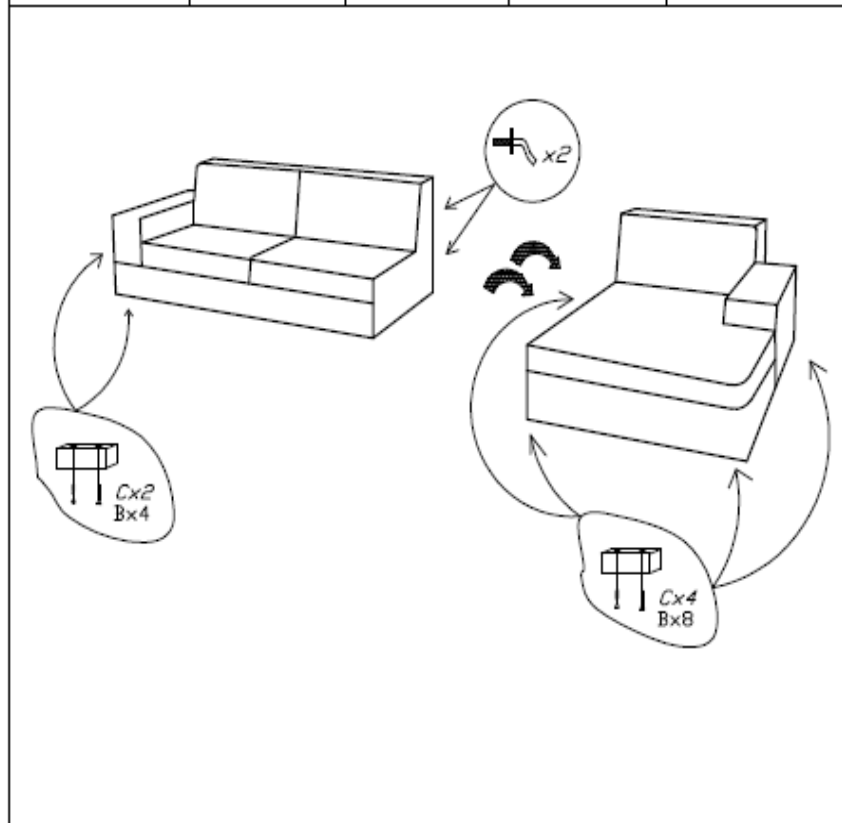
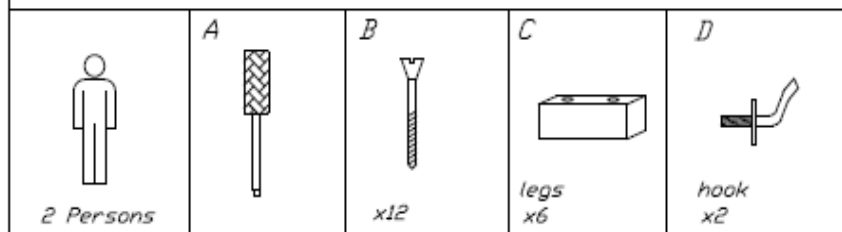

MODEL "1586/87"

Chaislong



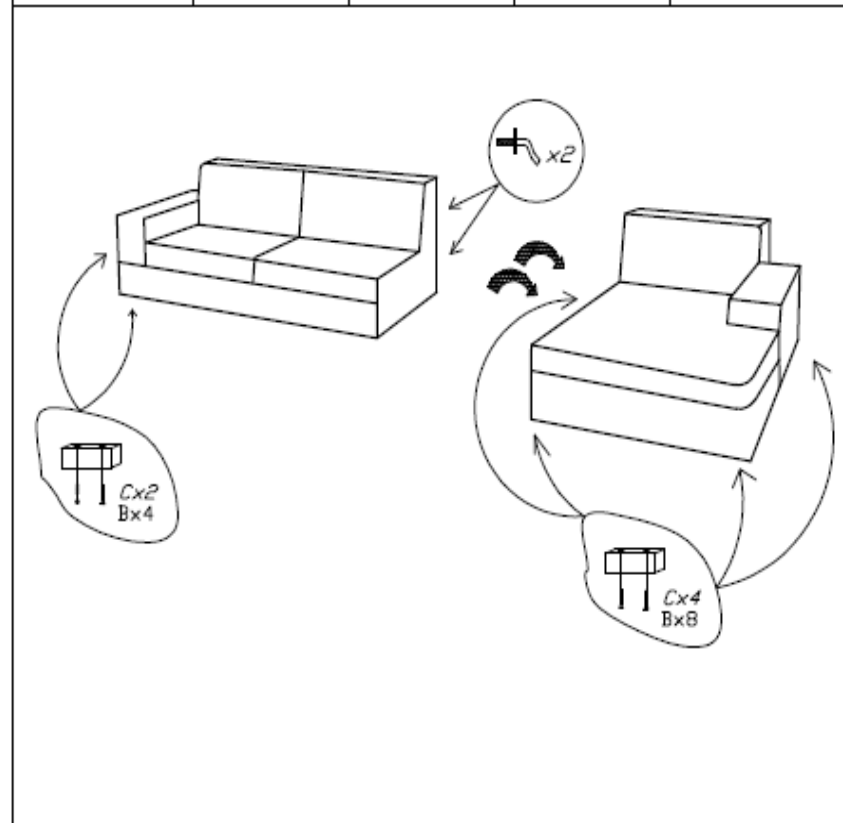
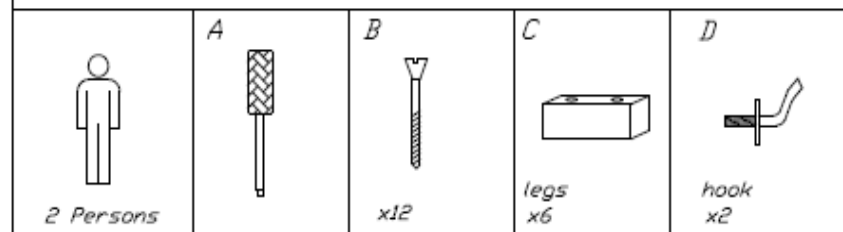







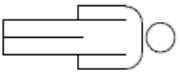
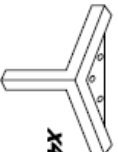



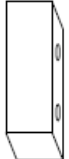

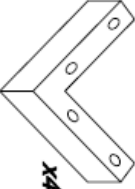

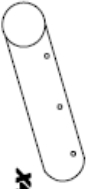

ASSEMBLY INSTRUCTION

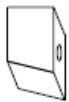

MODEL „A” „B” „C”

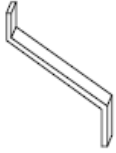
1p-2p-3p

ASSEMBLY INSTRUCTION



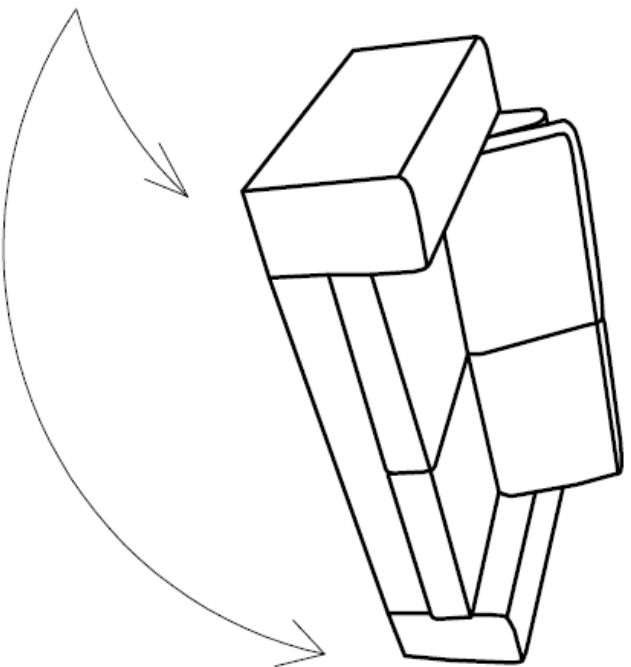
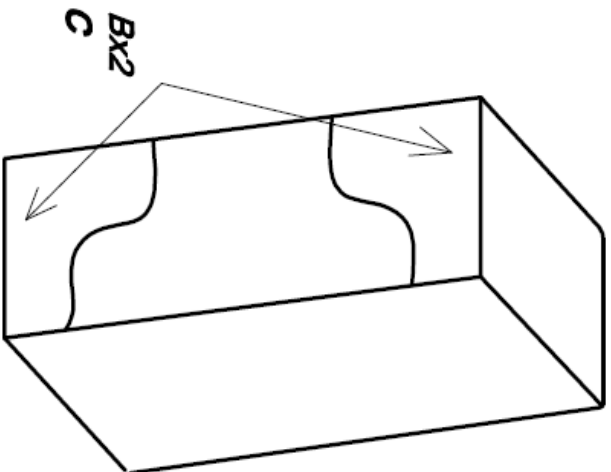

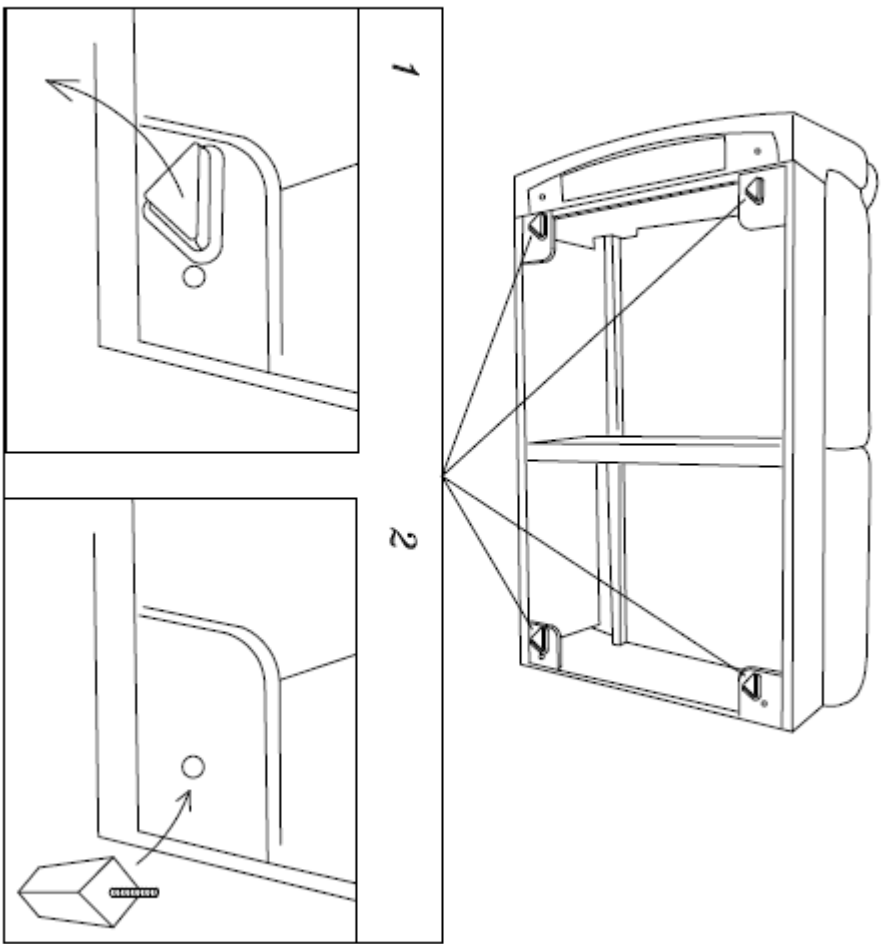
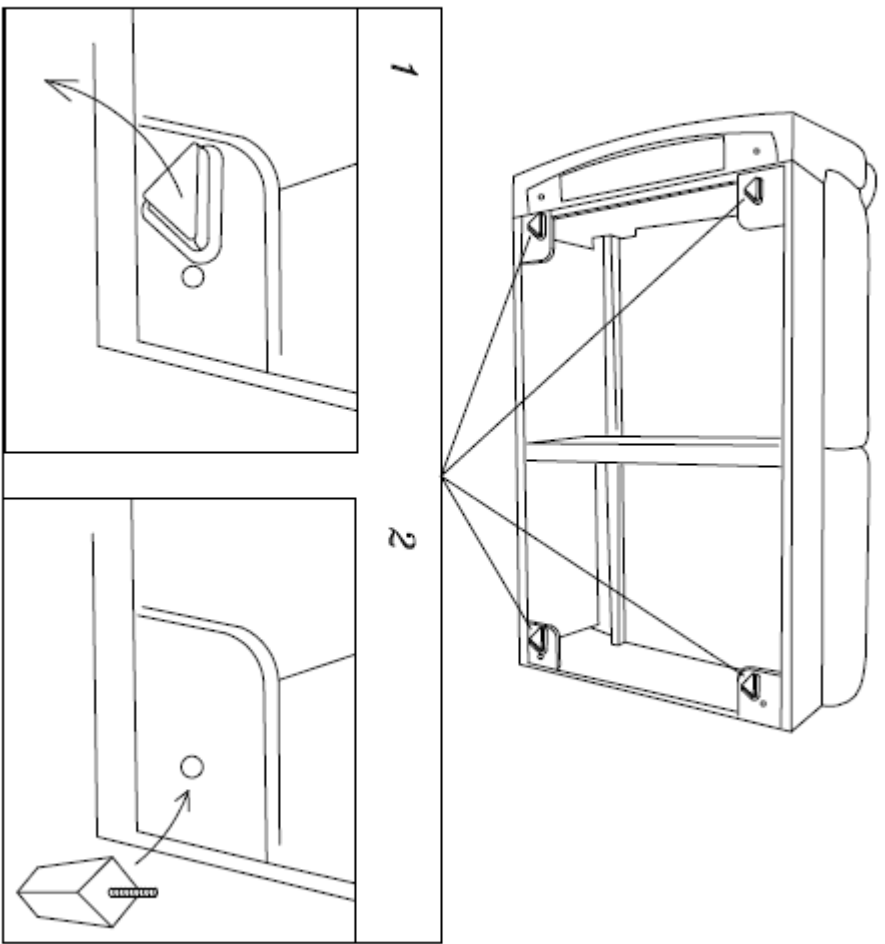
<p>2 Persons</p> 	<p>B legs</p>  <p>X4</p> <p>OR</p>  <p>X12</p>	 <p>OR</p>  <p>OR</p>	 <p>OR</p>  <p>OR</p>  <p>X8</p>	 <p>X4</p> <p>OR</p>  <p>X12</p>
<p>A</p> 	<p>B legs</p>  <p>X4</p> <p>OR</p>  <p>X12</p>	 <p>OR</p>  <p>X20</p>	 <p>OR</p>  <p>OR</p>  <p>X1</p>  <p>X4</p>	 <p>X4</p> <p>OR</p>  <p>X1</p>  <p>X4</p>  <p>X4</p>



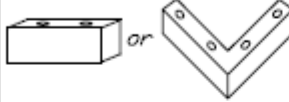

MODEL "1586"

ASSEMBLY INSTRUCTION

 2 Persons	A 	B 	C legs 	D  hook	E 
---	--	--	---	--	--

TO CONNECT THIS PARTS USE :

1. B12H, B12V, BH, BV, C12H, C12V, CH, CV:

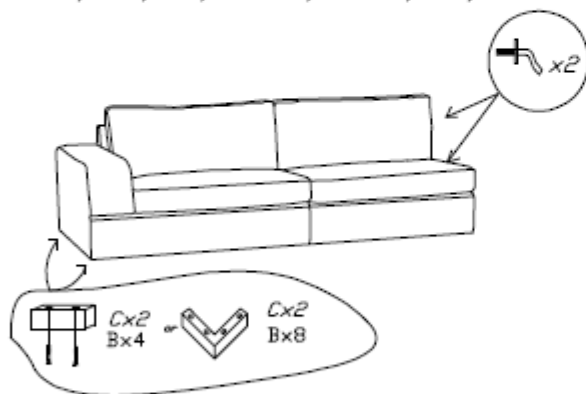

2. B0, C0:



3. THJ :

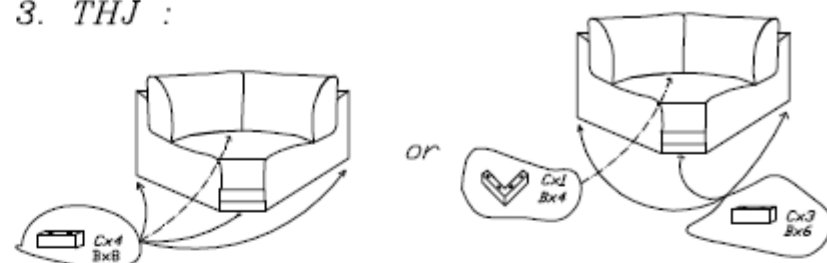

4. ULH, ULV, USH, USV :

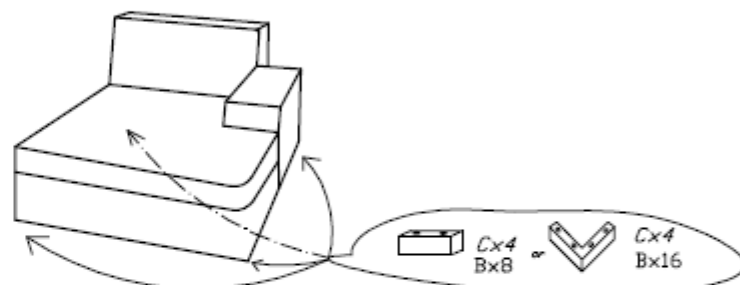

5. XH, XV :

- with THJ



- with B0, C0



6. LL, LS :

